

2-JAW PARALLEL GRIPPERS

INSTALLATION SIZE GP19

1

Installation size GP19 / 2-Jaw Parallel Grippers / pneumatic / Grippers

▶ PRODUCT SPECIFICATIONS



▶ Gripping force diagram

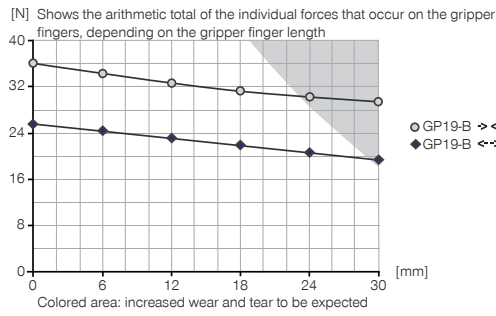

▶ Forces and moments

Displays static forces and moments that can also have an effect, besides the gripping force.

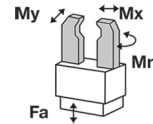

Mr [Nm]	0.8
Mx [Nm]	0.8
My [Nm]	0.8
Fa [N]	40

▶ RECOMMENDED ACCESSORIES



Universal Jaw Aluminium

UB19

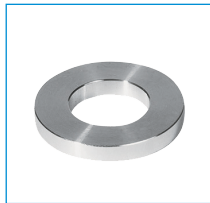

Centering Disc

ZE12H7X4



Mounting block

KB3

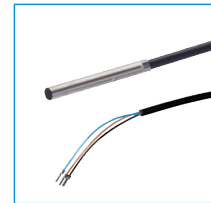

Inductive proximity switch
- Cable 5 m

NJ3-E2



Inductive Proximity
Switch Cable 0,3 m -
Connector M8
NJ3-E2SK

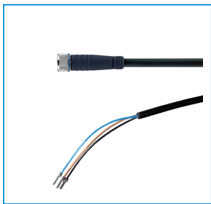

Plug-in connector Straight Ca-
ble 5m - Socket M8 (female)

KAG500



Straight Fittings - Quick
Connect Style

GVM5



Angled Fittings - Quick
Connect Style

WVM5

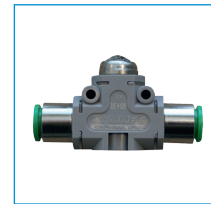

Quick Exhaust Valve

DEV04

Order no.	GP19-B
Stroke per jaw [mm]	4
Gripping force in closing [N]	36
Gripping force in opening [N]	26
Gripping force secured by spring min. [N]	
Closing time [s]	0.02
Opening time [s]	0.02
Repetition accuracy +/- [mm]	0.05
Operating pressure min. [bar]	3
Operating pressure max. [bar]	8
Operating temperature min. [°C]	5
Operating temperature max. [°C]	+80
Air volume per cycle [cm ³]	1
Weight [kg]	0.081

*All data measured at 6 bar

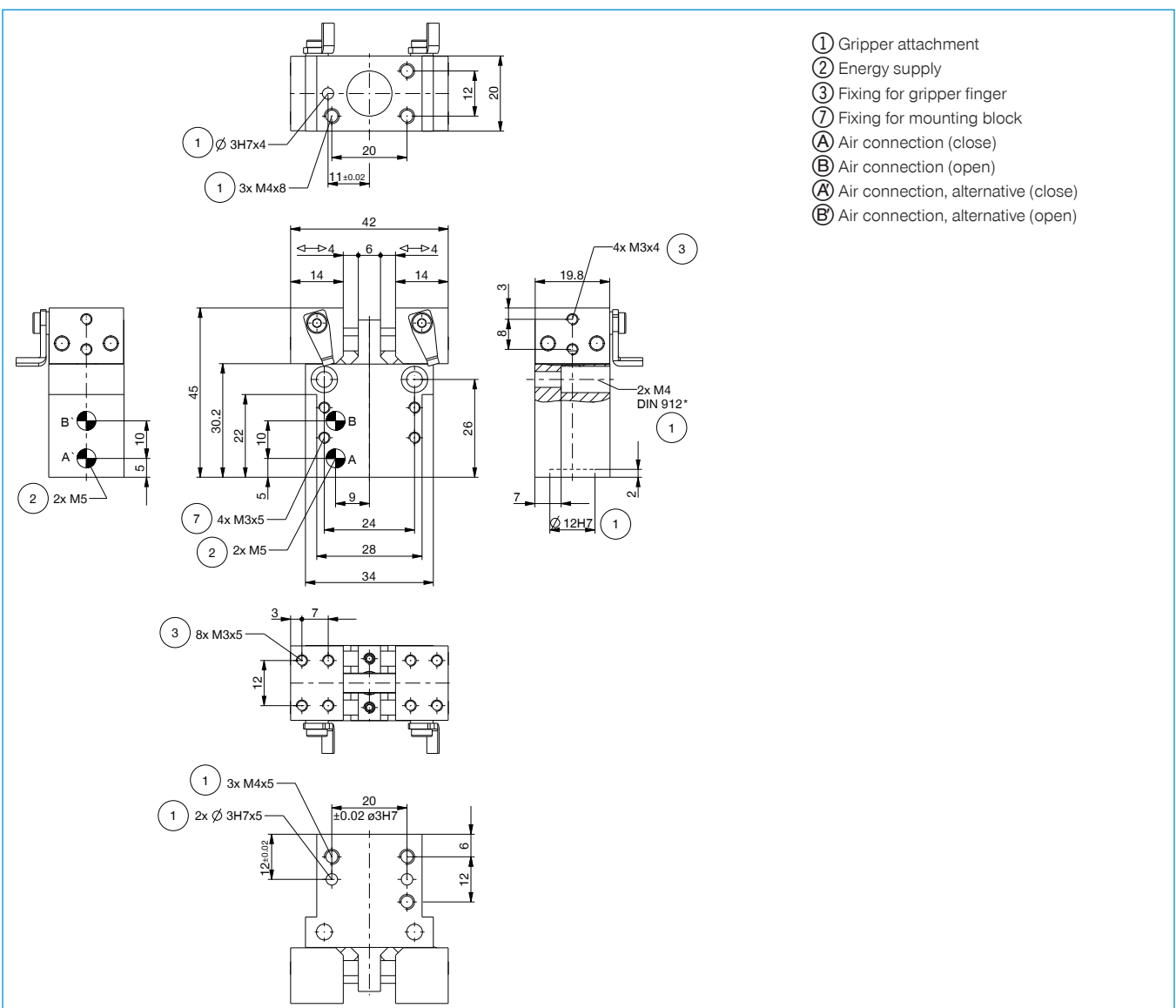

2-JAW PARALLEL GRIPPERS

SERIES GP

▶ PRODUCT ADVANTAGES

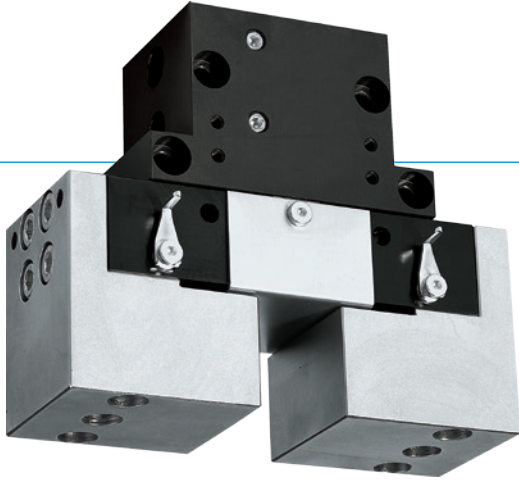

“The enduring”

▶ Proven technology

We have more than 20 years of proven reliability, which ensures uninterrupted production for you

▶ Very short cycle times

Low-friction circular guides enable very short cycle times and, therefore, high component output for your machine

▶ Failure-free continuous operation

Our uncompromising „Made in Germany“ quality guarantees up to 10 million maintenance-free cycles

▶ THE BEST PRODUCT FOR YOUR APPLICATION

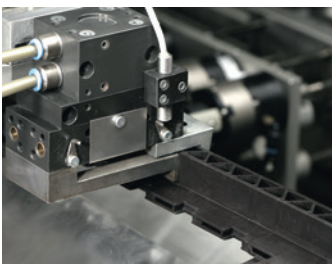

▶ Our products welcome the challenge!

Extreme conditions, all over the world—our tried and tested components and systems give you endless possibilities.

Find the best product for your specific use:

www.zimmer-group.de

HOW TO ORDER CORRECTLY

- ▶ The product order numbers are arranged according to this diagram:

Order no.	GP45	<input type="checkbox"/>	-B	
For external gripping, self-locking, spring closing		S		
Without intergrated spring				-99



► BENEFITS IN DETAIL

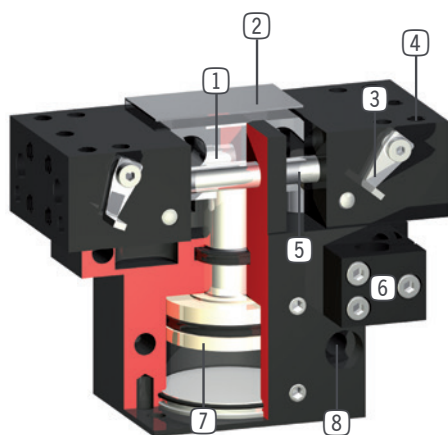

- ① **Wedge hook mechanism**
 - synchronized the movement of the gripper jaws
 - high force transfer
- ② **Cover plate**
 - to protect the guide and mechanics (from GP45)
- ③ **Adjustable switch cam**
 - for position sensing
- ④ **Gripper jaw**
 - individual gripper finger mounting
- ⑤ **Roller slide**
 - for low wear movement sequence
- ⑥ **Mounting block**
 - mounting for inductive proximity switch
- ⑦ **Drive**
 - double-acting pneumatic cylinder
- ⑧ **Mounting and positioning**
 - mounting possible from several sides for versatile positioning

► SERIES CHARACTERISTICS



Number of installation sizes	6
Stroke per jaw	3 mm - 13 mm
Gripping force	4 N - 5250 N
Weight	0,033 kg - 1,4 kg
AP class	2



10 million maintenance-free cycles (max.)



Spring closing C



Inductive sensor



IP30